

Cory Nestable Pallet 1212SH BLS 1212 SH

BLS 1212 SH is oneway nestable plastic pallet with higher loading capacities.

Feature:

- Lightweight
- Nestability
- Save on freight costs
- Cost effective
- Easy Cleaning
- Safe to handle
- Resistant to insects, bacteria and fungi
- Environmental friendly

Product Specification

Item No	: BLS 1212 SH		
Description	: Cory Nestable Pallet 1212SH		
Style	: Nestable		
Bottom Support	: 3 Runners		
Size W x L x H	: 1200 x 1200 x 90	mm	48 x 48 x 3.54 in
Material	: PP		
Colour	: Black		

Load Data

Static Load	: 2500	kg	5511	lb
Dynamic Load	: 2000 (w wrapping)	kg	4409	lb
	: 1000 (w/o wrapping)	kg	2204	lb
Racking Load	: N/A	kg	N/A	lb

Function Data

Forklift		: 2 way
Handlift		: N/A
Stacker		: N/A

Options

Anti Slip	: No
Snap on Bottom Skids	: No
With rim	: No
Without rim	: Yes

Container Loading

20"	: 646	pcs
40"	: 998	pcs
40 HQ	: 1088	pcs

Technical Drawing

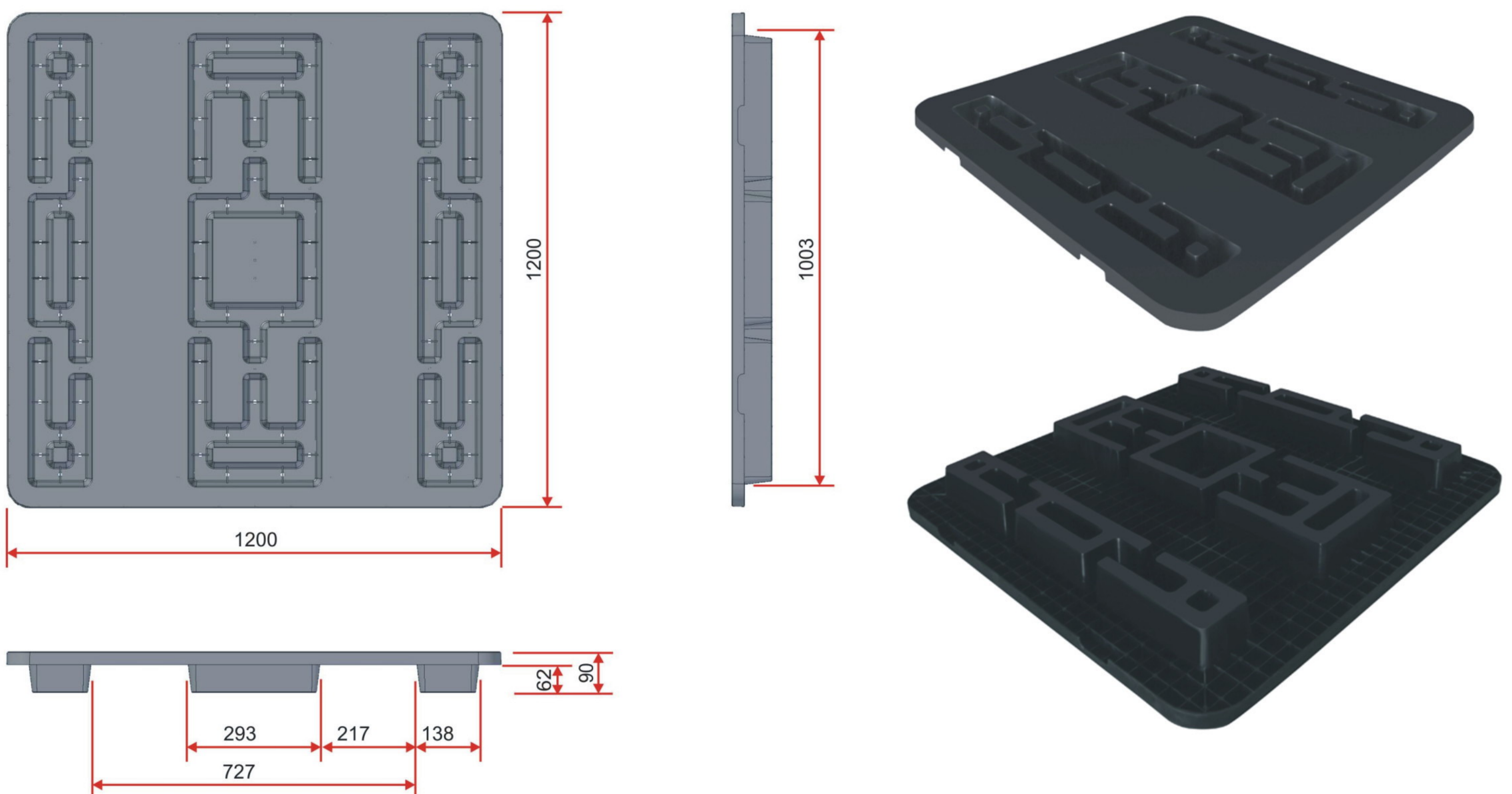

WINNER INTER PLAS CO., LTD.